



Access the GV-IP Camera through a broadband modem

Article ID: GV15-12-03-26

Release Date: 03/26/2012

Applied to

All GV-IP Cameras

Introduction

The document introduces how to connect your GV-IP Camera to the Internet through the broadband modem such as an ADSL or a TV-cable modem. Whenever you connect to the Internet, you can remotely access your camera and monitor the surveillance site.

A. A simple network environment	2
Step 1 Connecting your camera to a PC	3
Step 2 Registering a domain name for your camera	3
Step 3 Enabling the Internet connection	6
Step 4 Logging in your camera remotely	7
B. Local Area Network	8
Step 1 Finding the private IP address of your camera	9
Step 2 Assigning a different port to each camera	11
Step 3 Registering a domain name for the router	13
Other ports used by GV-IP Camera	15
Step 4 Logging in your camera remotely	22
C. Wireless Connection	24
D. Remote Viewing	29
1. Web Browser	29
2. GV-System/GV-NVR	29
3. Mobile Phone	34
F. Remote Playback	38



A. A simple network environment

If your network environment is simple with a few IP cameras, one computer and one broadband modem, you can connect the GV-IP Camera directly to the Internet through the broadband modem, as illustrated below.

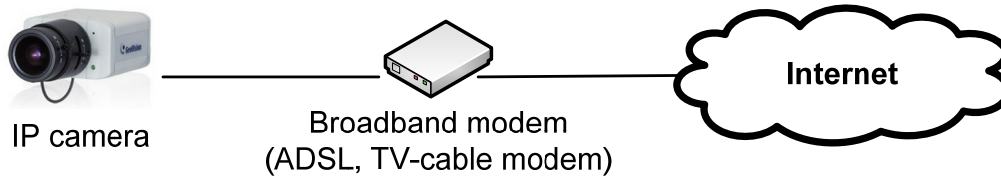

Note: One broadband modem may support more than one IP address, which includes fixed and dynamic IP addresses. In this case, you may connect several IP cameras directly to the Internet through one broadband modem. Please check your Internet Service Provider (ISP) for Internet packages.



Step 1 Connecting your camera to a PC

To log in the camera's Connect your camera to a PC to log in the camera's Web interface. By default the GV-IP Camera has the IP address of **192.168.0.10**, and ID and password are **admin**.

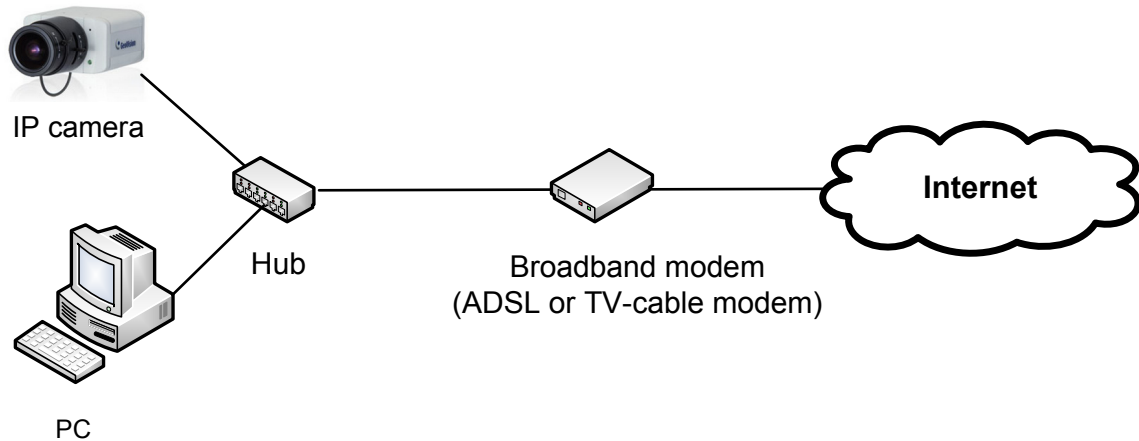

Login page:

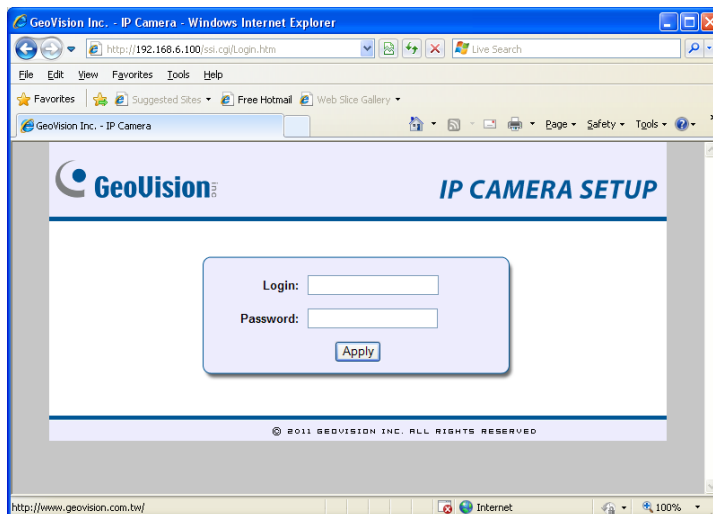

Step 2 Registering a domain name for your camera

Typically you receive a dynamic public IP address from the Internet Service Provider (ISP). To maintain one address to reach your camera, you may use Dynamic DNS service to obtain a domain name, such as geoipcamera.dipmap.com. The Dynamic DNS service will redirect the ever-changing IP address of your camera to the domain name. The GV-IP Camera supports two DDNS providers: GeoVision DDNS Server and DynDNS.org.

Note: Another alternative is to purchase a fixed public IP address from your ISP.



To register a domain name on GeoVision DDNS Server:

1. On the left menu of Web interface, select **Network** and then **Advanced TCP/IP**.

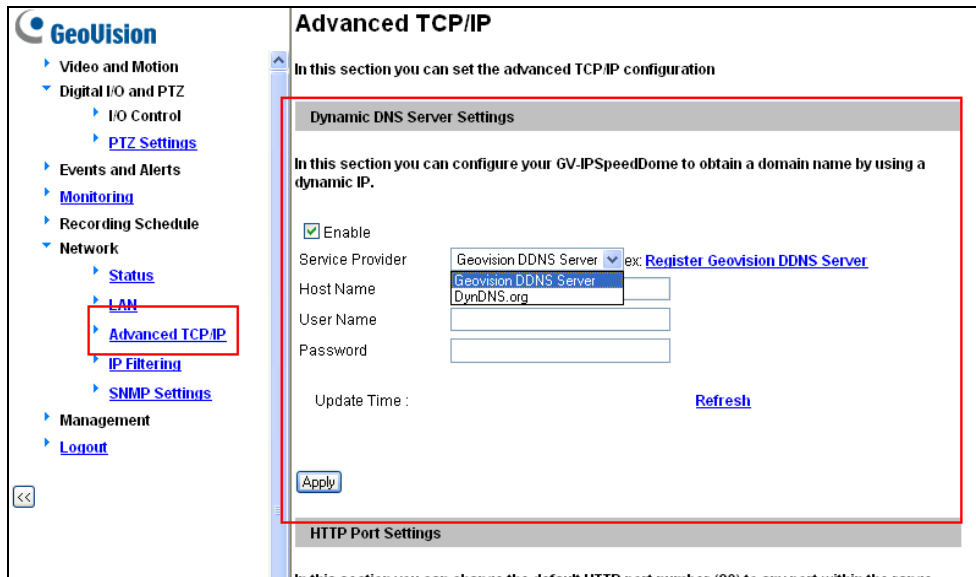

2. Under the Dynamic DNS Server Settings, select **Enable** and click the **Register GeoVision DDNS Server** link ex: [Register GeoVision DDNS Server](#) to access GeoVision DDNS service.
3. In the GeoVision DDNS Server page, type a desired **Username** and **Password**. Type the verification letters shown in the image, and click **Send**.

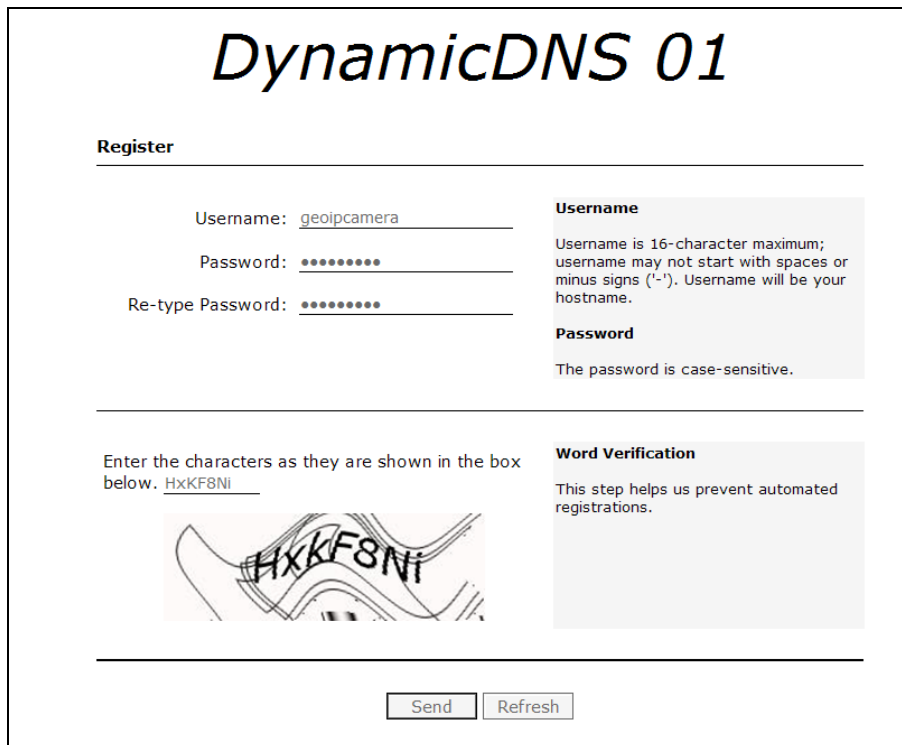



4. You receive a hostname from GeoVision DDNS Server, as illustrated below. **The hostname, e.g. geoipcamera.dipmap.com, will be the domain name of your IP camera.**

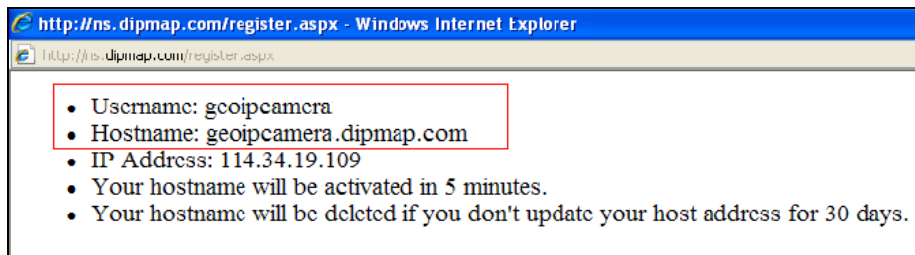

5. On the camera's Web interface, type the **Username** and **Password** you registered on the DDNS Server. Click **Apply** to enable the DDNS service. The Update Time should appear to indicate the update time from the DDNS server.

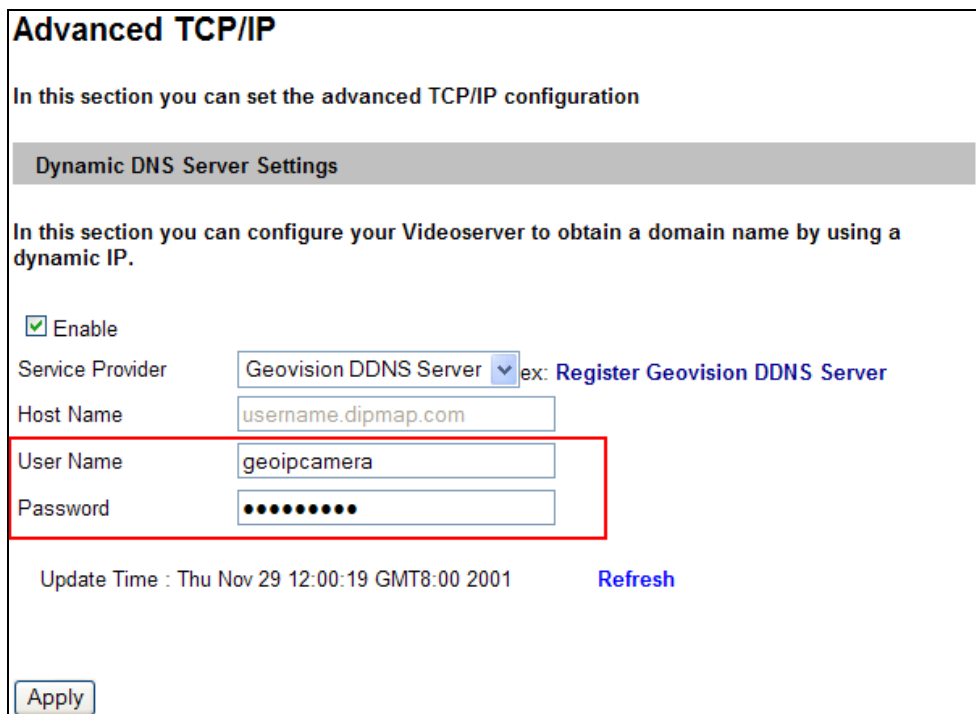



Step 3 Enabling the Internet connection

ADSL users

1. On the left menu of the Web Interface, select **Network** and then **LAN**.
2. Select **PPPoE**, and type **Username** and **Password** provided by your ISP.
3. Click **Apply** to enable the Internet connection.

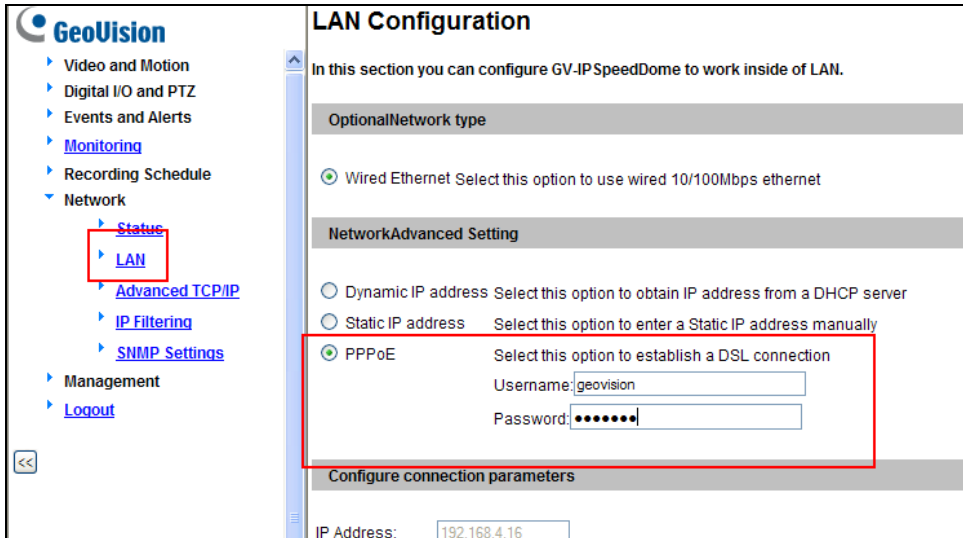

TV-cable modem users

If you are a TV-cable modem user, you don't need to dial-up every time when you want to log on because the connection is always on.

1. On the left menu of the Web interface, select **Network** and then **LAN**.
2. Select **Dynamic IP address**.
3. Click **Apply** to enable the Internet connection.

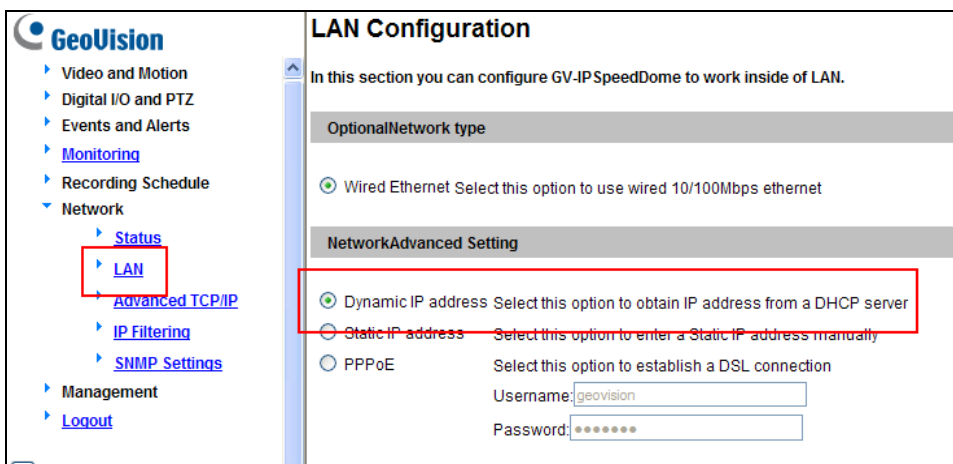



Step 4 Logging in your camera remotely

Now you can log in your camera remotely from a computer.

1. Start the Internet Explorer.
2. Type the domain name you registered for your IP camera, like this:
<http://geoipcamera.dipmap.com>. The domain name will link you to the IP camera.
3. When the Login page appears, type the default ID and Password **admin** to login.
4. When the message of adding “ActiveX Control” appears, right-click the message and select **Run Add-on** to install ActiveX component of Internet Explorer to your computer.

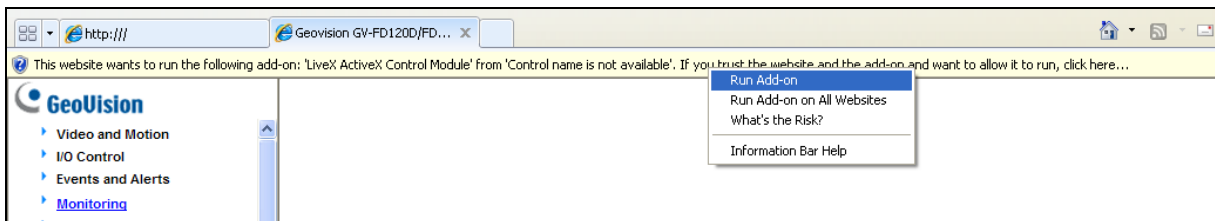

5. When the message of adding ActiveX Control from GeoVision appears, right-click the message and select **Run Add-on** to install GeoVision’s ActiveX component to your computer.

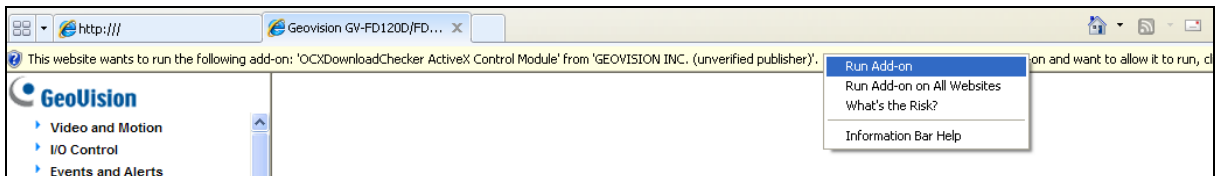

6. Live images appear now.



B. Local Area Network

If you have multiple IP cameras installed on a local area network (LAN), with a router connected to a broadband modem, the router will typically assign private IP addresses to the connected cameras such as 192.168.x.x. You cannot see the IP cameras outside from the Internet by using the private IP addresses (192.168.x.x). What you use on the Internet is the public IP address from the ISP, which is the IP address of your router.

To allow access to the IP cameras residing on the LAN, you need to assign a different port to each camera and open the corresponding ports on the router. Let's imagine the public IP address of the router is like a building's address, and ports are like the apartment numbers for the residences in the building. When each IP camera has a unique port number, the router will know where to forward the request outside from the Internet. This process is also known as port forwarding or port mapping.

The LAN environment:

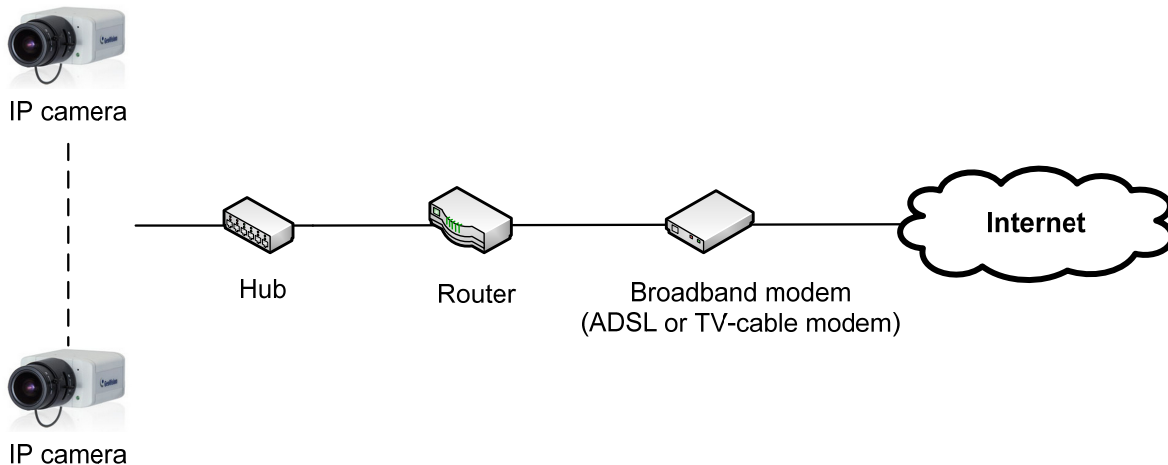

Port forwarding from the router:

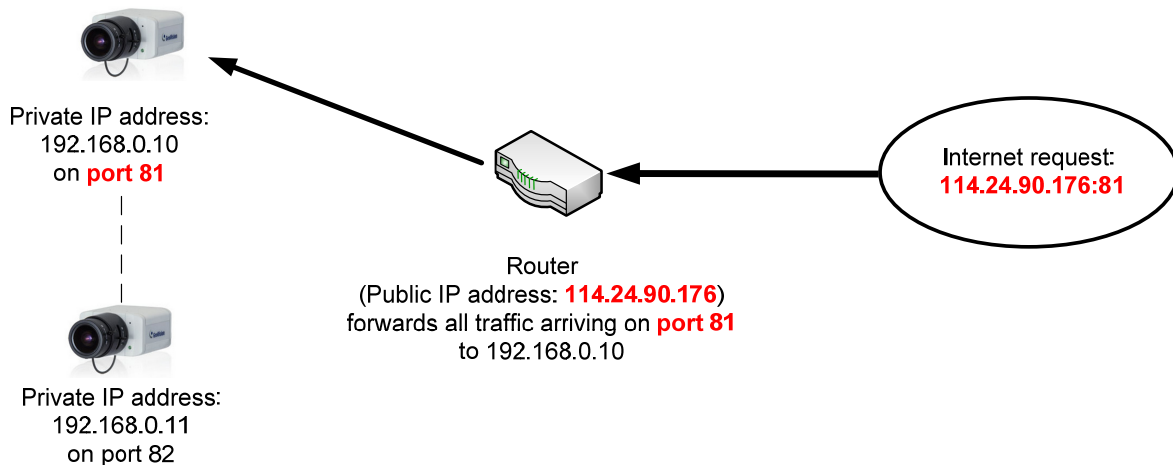



Step 1 Finding the private IP address of your camera

The router usually has the DHCP Server function to automatically assign a dynamic IP address to the network devices. When the GV-IP Camera is connected to the network for the first time, it will also be assigned a dynamic IP address.

To find the private IP address of your camera:

1. Install the **GV-IP Device Utility** from the GV-IPCAM H.264 Software CD.



2. On the GV-IP Utility window, click the  button to search for the devices connected in the same LAN.
3. Find the camera with its Mac Address, click on its **IP address** and select **Web Page**.

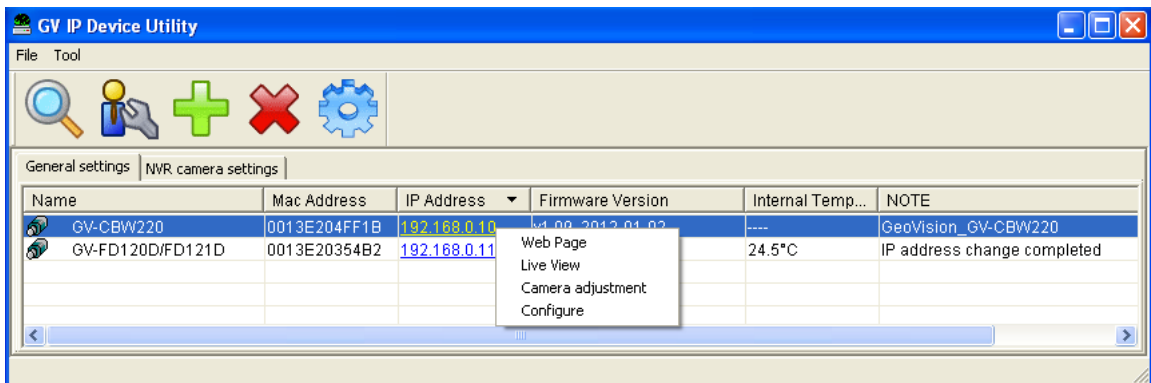

Note: You can find the Mac Address on a sticker on the GV-IP Camera.



4. The Login page appears.

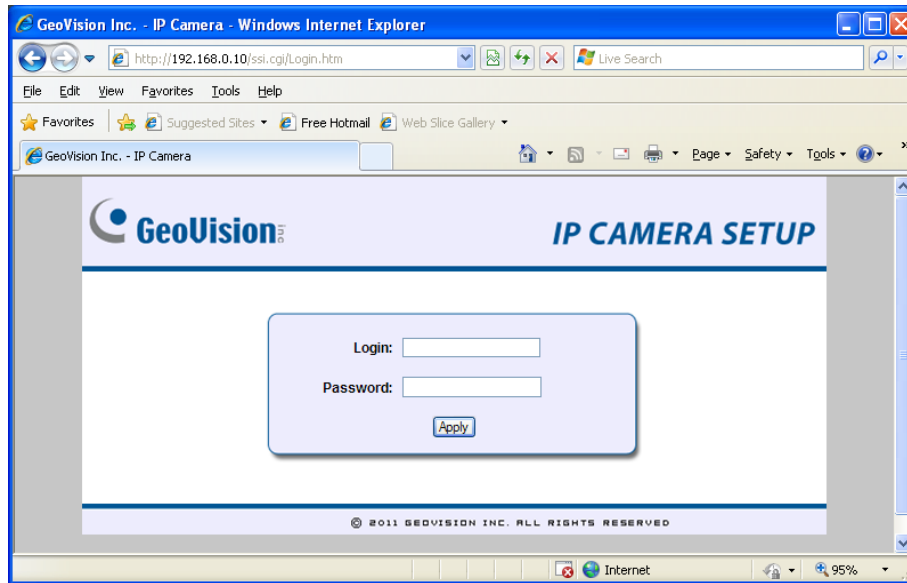

5. Type the default ID and password **admin**, and click **Apply** to log in.



Step 2 Assigning a different port to each camera

Log in the Web interface of each camera and give them different HTTP and VSS port values.

HTTP port

The HTTP port enables connection of an IP camera to the Internet. The default HTTP port for every network device is 80. Since the port 80 will be taken by the router, you need to assign a different HTTP port for each camera starting from port 81 to avoid port conflicts.

VSS (Streaming) port

If you are the user of GV-System/GV-NVR, you must assign a different streaming port for each camera to connect to the GV-System/GV-NVR. The default streaming port for every GV-IP Camera is 10000.

For example, if you have two IP cameras on LAN, you may arrange your port settings like this:

Cameras on LAN	Ports			
Camera 1 (192.168.0.10)	HTTP	81	VSS	10000
Camera 2 (192.168.0.11)	HTTP	82	VSS	10001

Note:

- Once you change the default HTTP port 80, you will need to type the IP address followed by a colon and the specified port value to access the camera either on the LAN or from the Internet. For example, the HTTP port of Camera 1 is changed to 81, so you need to type its IP address like this: 192.168.0.10:81.
 - You may find the Surveillance System Software DVD for GV-System/GV-NVR in the GV-IP Camera package. For detail see [GV-System/GV-NVR](#) in the *D. Remote Viewing* section later in this document.
-



To change default HTTP and VSS (Streaming) ports on the camera:

1. On the left menu of the Web interface, select **Network** and then **Advanced TCP/IP**.
2. Under the HTTP Port Settings, change the default port 80 and click **Apply**.
3. Under the Streaming Port Settings, change the default port 10000 and click **Apply**.

The screenshot displays the web interface's network configuration page. On the left, a navigation menu lists various settings, with 'Advanced TCP/IP' under the 'Network' section highlighted in red. The main content area is divided into three sections, each enclosed in a red box:

- HTTP Port Settings:** This section allows changing the default HTTP port from 80 to any port between 1024 and 65535. The current value is 81, and an 'Apply' button is present.
- HTTPS Settings:** This section allows changing the default HTTPS port from 443 to any port between 1024 and 65535. The current value is 443. It includes an 'Enable' checkbox, a warning message about external storage, and fields for 'Certification', 'Private Key', and 'Password', each with a 'Browse...' button. An 'Apply' button is at the bottom.
- GV-IPCAM Streaming Port Settings:** This section allows configuring the streaming connection port. The current value is 10000, and an 'Apply' button is at the bottom.



Step 3 Registering a domain name for the router

Typically you receive a dynamic IP address from your ISP. You may register a domain name linking to the ever-changing IP address of the router. Most broadband routers support a dynamic DNS service such as www.dyndns.org. Please check your router's Web interface and document for the Dynamic DNS settings.

Note: Another alternative is to purchase a fixed public IP address from your ISP.

The following example is the Dynamic DNS settings on the D-Link DIR-825 router.

The screenshot shows the web interface of a D-Link DIR-825 router. The left sidebar contains a menu with items: ADMIN, TIME, SYSLOG, EMAIL SETTINGS, SYSTEM, FIRMWARE, **DYNAMIC DNS** (highlighted with a red box), SYSTEM CHECK, SCHEDULES, and a language dropdown set to English. The main content area is titled 'DYNAMIC DNS' and includes a descriptive paragraph, a sign-up prompt for D-Link's Free DDNS service, and two buttons: 'Save Settings' and 'Don't Save Settings'. Below this is a configuration form with the following fields:

- Enable Dynamic DNS :**
- Server Address :**
- Host Name :**
- Username or Key :**
- Password or Key :**
- Verify Password or Key :**
- Timeout :** (hours)
- Status :** Connected



Step 4 Opening ports on the router

Log in the router's Web interface and look for the port forwarding settings. **You should correlate public ports with the corresponding private IP of the camera.**

Note: Each manufacture has different software used on their routers. We took screenshots of the port forwarding settings from **D-Link DIR-825** model. We are assuming you know how to access your router, and know the proper ID and password. If you don't know, check out the router's manual or manufacturer's website.

Based on our previous port arrangements, two different HTTP ports are set up for two cameras (see the red highlight below), and two different VSS ports are set up for connecting to the GV-System/GV-NVR (see the blue highlight below).

Cameras on LAN	Ports			
Camera 1 (192.168.0.10)	HTTP	81	VSS	10000
Camera 2 (192.168.0.11)	HTTP	82	VSS	10001

In the following example of D-Link DIR-825 router, the port forwarding settings are in the Advanced tab. We have opened the HTTP and VSS ports for Camera 1 and 2 on the router.



24 — VIRTUAL SERVERS LIST						
	Name	IP Address	Port	Traffic Type	Protocol	Schedule
<input checked="" type="checkbox"/>	HTTP-1	192.168.0.10	Public Port: 81 Private Port: 81	6	TCP	Always
<input checked="" type="checkbox"/>	HTTP-2	192.168.0.11	Public Port: 82 Private Port: 82	256	Both	Always
<input checked="" type="checkbox"/>	VSS-1	192.168.0.10	Public Port: 10000 Private Port: 10000	6	TCP	Always
<input checked="" type="checkbox"/>	VSS-2	192.168.0.11	Public Port: 10001 Private Port: 10001	6	TCP	Always



Other ports used by GV-IP Camera

The HTTP and VSS (streaming) ports allow your IP cameras on the LAN connected to the Internet and GV-System/GV-NVR. To have more features of GV-IP Camera, you need to open the following ports on the router.

Port type	Value
HTTPS	443
RTSP	8554
FTP	21
ViewLog	5552

[HTTPS port]

By opening the Hypertext Transfer Protocol Secure (HTTPS) port, you can access the camera through a secure protocol. When the HTTPS port is enabled on the GV-IP Camera and the router, you will securely access your camera using a HTTPS URL that starts with **https://**, instead of using HTTP URL that starts with **http://**.

First of all, you need to assign a different HTTPS port for each IP camera, and then open the corresponding ports on the router.

By default the HTTPS port is 443, which will be taken by your router. If you have two IP cameras on LAN, the port settings may look like this:

Cameras on LAN	Ports			
Camera 1 (192.168.0.10)	HTTPS	444	VSS	10000
Camera 2 (192.168.0.11)	HTTPS	445	VSS	10001



To assign and open the HTTPS port:

1. On the left menu of the camera Web interface, select **Network** and then **Advanced TCP/IP**.

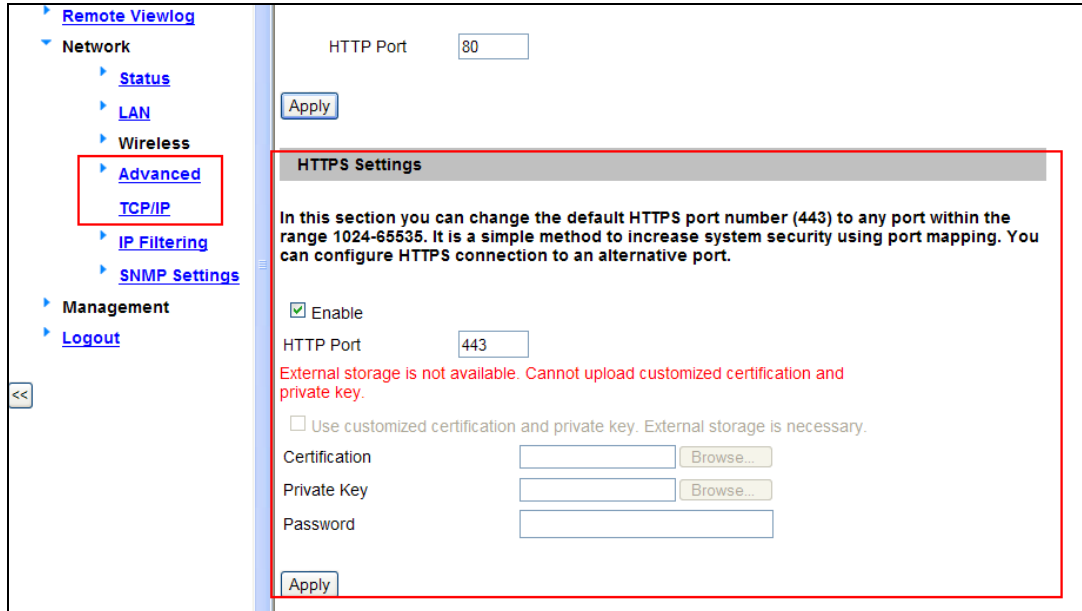

2. Under the HTTPS Port Settings, select **Enable**, change the default port 443 and click **Apply**.
3. For how to use the customize certificate and password, see the *Advanced TCP/IP* section, *Chapter 13 Administrator Mode, GV-IPCAM H.264 User's Manual* on the GV-IPCAM H.264 Software DVD.
4. Open the HTTPS port of the camera on the router. Take the D-Link's router as example:

<input checked="" type="checkbox"/>	Name	Application Name	Public Port	Protocol	Schedule
	HTTPS		444	TCP	Always
	IP Address	Computer Name	Private Port		Inbound Filter
	192.168.0.10		444	6	Allow All
<input checked="" type="checkbox"/>	Name	Application Name	Public Port	Protocol	Schedule
	HTTPS		445	TCP	Always
	IP Address	Computer Name	Private Port		Inbound Filter
	192.168.0.11		445	6	Allow All
	Name		Public Port	Protocol	Schedule



[RTSP port]

When the RTSP port is opened on the GV-IP Camera and the router, you can view the live video by using VLC and Quick Time players with the RTSP commands.

First of all, you need to assign a different RTSP port for each IP camera, and then open the corresponding ports on the router. If you have two IP cameras on LAN, the port settings may look like this:

Cameras on LAN	Ports					
Camera 1 (192.168.0.10)	HTTP	81	VSS	10000	RTSP	8554
Camera 2 (192.168.0.11)	HTTP	82	VSS	10001	RTSP	8555

To assign and open the RTSP port:

1. On the left menu of the camera Web interface, select **Events and Alerts** and then **RTSP**. (By default the RTSP port is enabled on the GV-IP Camera.)

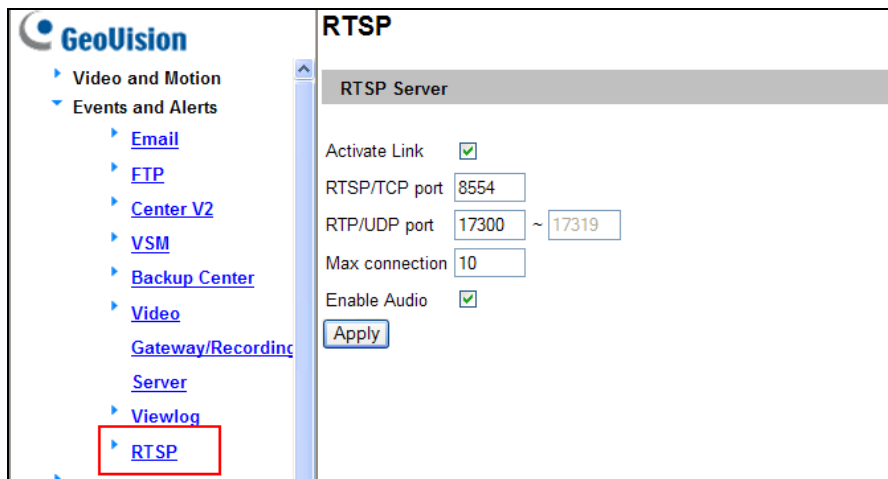

2. Change the default RTSP/TCP port 8554, and click **Apply**.
3. On the router, open the RTSP port of the camera. Take the D-Link's router as example:

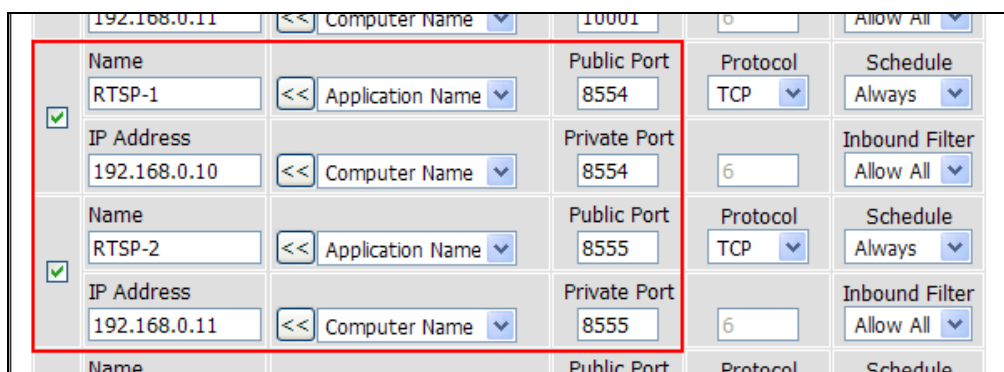



The RTSP Command:

If you use the QuickTime player, enter:

rtsp://<IP or domain name of the GV-IPCAM:8554/<CH No.>.sdp

For example, <rtsp://geoipcamera.dlinkddns.com:8554/CH001.sdp>

If you use the VLC player, enter:

rtsp://username:password@<IP or domain name of the GV-IPCAM:8554/<CH No.>.sdp

For example, <rtsp://admin:admin@dlinkddns.com:8554/CH001.sdp>

For detail, see the *RTSP* section, *Chapter 13 Administrator Mode, GV-IPCAM H.264 User's Manual* on the GV-IPCAM H.264 Software DVD.

[FTP port]

When the FTP port is opened on the GV-IP Camera and the router, the GV-IP Camera will have two capabilities: (1) send the captured still image to a remote FTP server for alerts, and (2) act as a FTP server to allow users to download AVI files.

First of all, you need to assign a different FTP port for each IP camera, and then open the corresponding ports on the router. If you have two IP cameras on LAN, the port settings may look like this:

Cameras on LAN	Ports					
Camera 1 (192.168.0.10)	HTTP	81	VSS	10000	FTP	21
Camera 2 (192.168.0.11)	HTTP	82	VSS	10001	FTP	22



To assign and open the FTP port:

1. On the left menu of the camera Web interface, select **Events and Alerts** and then **FTP**.

2. In the Upload to a FTP Server section, select **Enable** and type the login information of a remote FTP server. For detailed instructions, see the *FTP* section, *Chapter 13 Administrator Mode, GV-IPCAM H.264 User's Manual* on the GV-IPCAM H.264 Software DVD.
3. Change the default FTP port 21, and click **Apply**.
4. The GV-IP Camera can also function as a FTP server allowing you to download AVI files. For this feature, select **Enable ftp access to GV-IPCAM**, change the default FTP port 21 and click **Apply**.
5. On the router, open the FTP port of the camera. Take the D-Link's router as example:

<input checked="" type="checkbox"/>	Name	FTP-1	Application Name	Public Port	21	Protocol	TCP	Schedule	Always
	IP Address	192.168.0.10	Computer Name	Private Port	21	6		Inbound Filter	Allow All
<input checked="" type="checkbox"/>	Name	FTP-2	Application Name	Public Port	22	Protocol	TCP	Schedule	Always
	IP Address	192.168.0.11	Computer Name	Private Port	22	6		Inbound Filter	Allow All
<input checked="" type="checkbox"/>	Name	ViewLog-1	Application Name	Public Port	5552	Protocol	TCP	Schedule	Always



To access the internal FTP servers of Camera 1 and Camera 2 outside from the Internet, enter the URL like this:

Camera 1: <ftp://geoipcamera.dlinkddns.com:21>

Camera 2: <ftp://geoipcamera.dlinkddns.com:22>

By default the login ID and password are **ftpuser**.

For detail, see the *FTP* section, *Chapter 13 Administrator Mode, GV-IPCAM H.264 User's Manual* on the GV-IPCAM H.264 Software DVD.

[ViewLog port]

When the ViewLog port is opened on the GV-IP Camera and the router, you can play back the video saved on the memory card of the camera.

First of all, you need to assign a different ViewLog port for each IP camera, and then open the corresponding ports on the router. If you have two IP cameras on LAN, the port settings may look like this:

Cameras on LAN	Ports					
Camera 1 (192.168.0.10)	HTTP	81	VSS	10000	ViewLog	5552
Camera 2 (192.168.0.11)	HTTP	82	VSS	10001	ViewLog	5553

To assign and open the ViewLog port:

1. On the left menu of the camera Web interface, select **Events and Alerts** and then **ViewLog**.

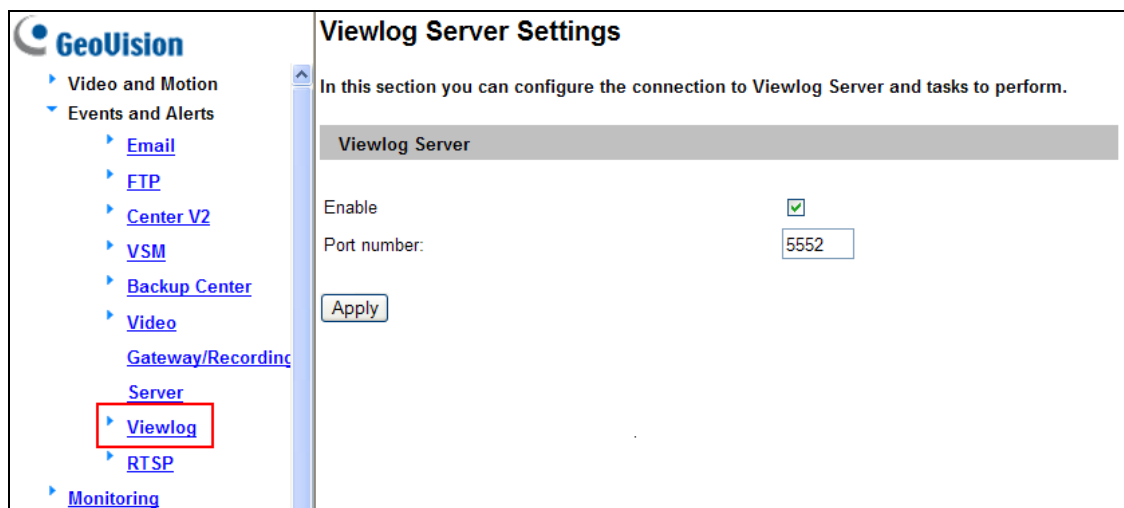



2. Select **Enable**, change the default port 5552, and click **Apply**.
3. On the router, open the ViewLog port of the camera. Take the D-Link's router as example:

<input checked="" type="checkbox"/>	Name	<< Application Name	Public Port	Protocol	Schedule
	ViewLog-1		5552	TCP	Always
	IP Address	<< Computer Name	Private Port		Inbound Filter
	192.168.0.10		5552	6	Allow All
<input checked="" type="checkbox"/>	Name	<< Application Name	Public Port	Protocol	Schedule
	ViewLog-2		5553	TCP	Always
	IP Address	<< Computer Name	Private Port		Inbound Filter
	192.168.0.11		5553	6	Allow All

For how to remotely play back video, refer to the [F. Remote Playback](#) section later in this document.



Step 4 Logging in your camera remotely

To access a specific IP camera residing on the LAN, follow the steps below.

1. Start the Internet Explorer.
2. Type the domain name of the router followed by a colon and the port number of the camera.

For example:

If you want to access Camera 1, type the URL like this: <http://geoipcamera.dlinkddns.com:81>;

If you want to access Camera 2, type the URL like this: <http://geoipcamera.dlinkddns.com:82>

Cameras on LAN	Ports			
Camera 1 (192.168.0.10)	HTTP	81	VSS	10000
Camera 2 (192.168.0.11)	HTTP	82	VSS	10001

If you enable the HTTPS ports,

type the URL like this to access Camera 1: <https://geoipcam.dlinkddns.com:444>;

type the URL like this to access Camera 2: <https://geoipcam.dlinkddns.com:445>

Cameras on LAN	Ports			
Camera 1 (192.168.0.10)	HTTPS	444	VSS	10000
Camera 2 (192.168.0.11)	HTTPS	445	VSS	10001

3. When the Login page appears, type the default ID and Password **admin** to login.
4. When the message of adding “ActiveX Control” appears, right-click the message and select **Run Add-on** to install ActiveX component of Internet Explorer to your computer.

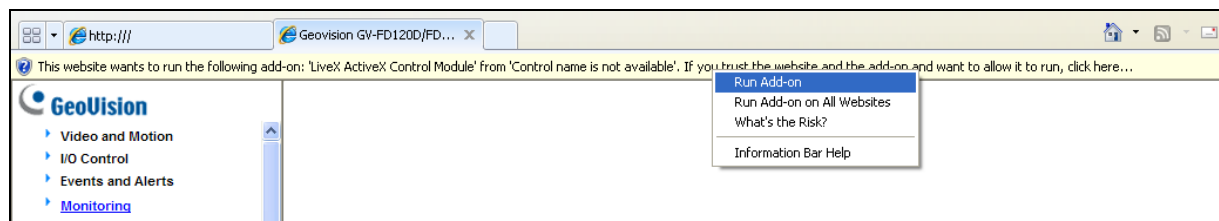

5. When the message of adding ActiveX Control from GeoVision appears, right-click the message and select **Run Add-on** to install GeoVision’s ActiveX component to your computer.

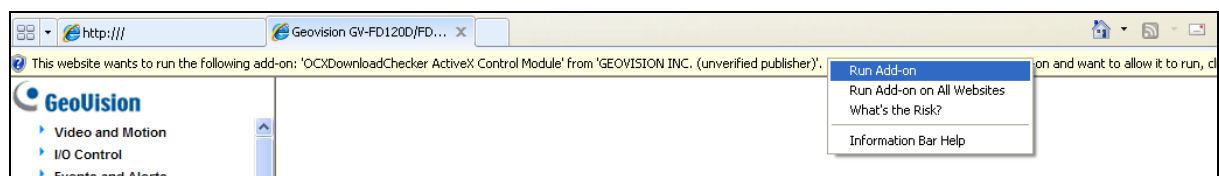



6. Live images appear now.

Note: When accessing the IP camera using HTTPS, the following warning message of security certificate will appear. Click **Continue to this website (not recommended)** to access the Login page of the camera.

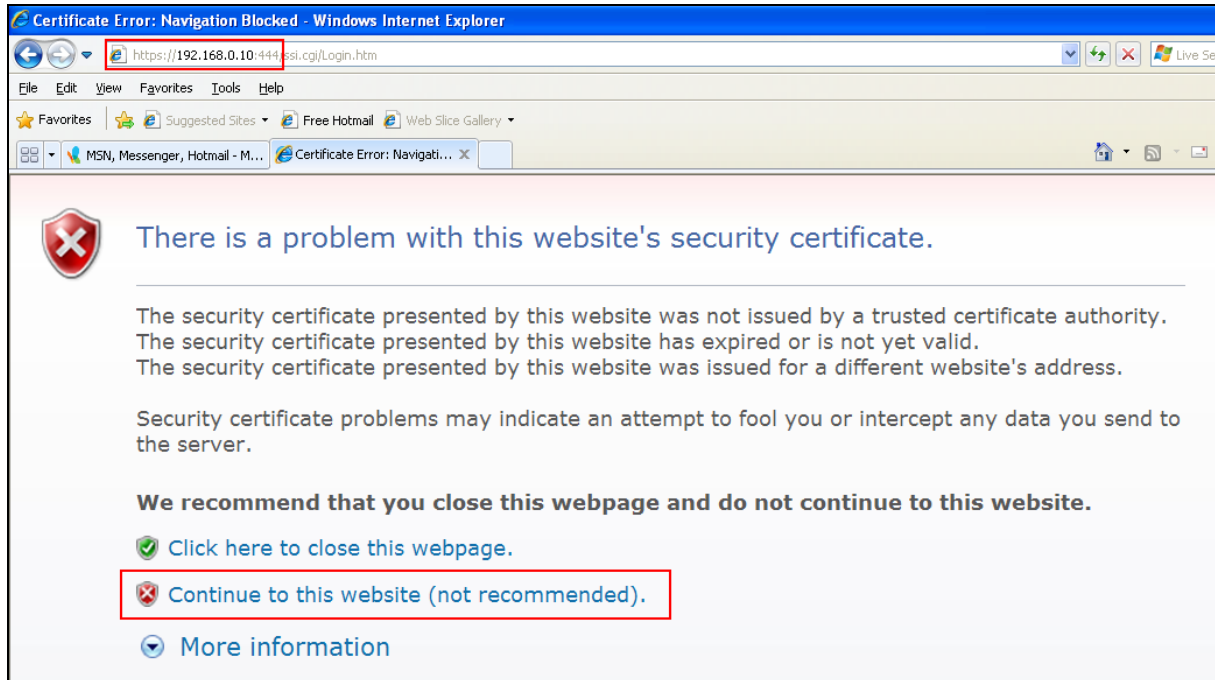



C. Wireless Connection

If you are using the wireless GV-IP Camera, set up the wireless connection.

Before you enable the wireless connection on the GV-IP Camera, you need to set up configure the wireless settings on the router. In the following instructions, we use the **D-Link DIR-825** router as example.

To configure wireless settings on the router:

1. Log in the router's Web interface and look for wireless settings.
2. Regardless of what software used on your router, you need to enter the following basic information.
 - A. **Wireless Band:** Select **2.4 GHz Band** settings. **The GV-IP Camera only supports 2.4 GHz wireless band.**
 - B. **Wireless Network Name:** Give a name to the wireless router.
 - C. **802.11 Mode:** Select **Mixed 802.11n, 802.11g and 802.11b**. **The GV-IP Camera supports 802.11n/g/b modes.**

D-Link

DIR-825 // SETUP ADVANCED TOOLS STATUS

INTERNET
WIRELESS SETTINGS
 NETWORK SETTINGS
 USB SETTINGS
 IPv6
 English

WIRELESS :

Use this section to configure the wireless settings for your D-Link Router. Please note that changes made on this section may also need to be duplicated on your Wireless Client.

Save Settings Don't Save Settings

WIRELESS NETWORK SETTINGS

Wireless Band : 2.4GHz Band

Enable Wireless : Always Add New

Wireless Network Name : Geo LAN (Also called the SSID)

802.11 Mode : Mixed 802.11n, 802.11g and 802.11b

Enable Auto Channel Scan :

Wireless Channel : 2.437 GHz - CH 6

Channel Width : 20 MHz

Visibility Status : Visible Invisible



3. You may enable the Wireless Security Mode, by which any wireless device needs to have the same encrypted method and password to connect to the wireless router. There are some basics for the security mode:
 - A. **Security Mode:** Select **WEP** or **WPA-Personal**. The GV-IP Camera supports the two modes.
 - B. If you select **WPA-Personal Mode**:
 - Select **WPA Only** or **WPA2 Only**. The GV-IP Camera supports the two modes.
 - Select **AES** or **TKIP**. The GV-IP Camera does NOT support the combined cipher type of **AES and TKIP**.
 - C. If you select **WEP Mode**, select **64 bit** or **128 bit**. The GV-IP Camera supports the two types of key lengths.

WIRELESS SECURITY MODE

To protect your privacy you can configure wireless security features. This device supports three wireless security modes including WEP, WPA-Personal, and WPA-Enterprise. WEP is the original wireless encryption standard. WPA provides a higher level of security. WPA-Personal does not require an authentication server. The WPA-Enterprise option requires an external RADIUS server.

Security Mode :

WPA

Use **WPA or WPA2** mode to achieve a balance of strong security and best compatibility. This mode uses WPA for legacy clients while maintaining higher security with stations that are WPA2 capable. Also the strongest cipher that the client supports will be used. For best security, use **WPA2 Only** mode. This mode uses AES(CCMP) cipher and legacy stations are not allowed access with WPA security. For maximum compatibility, use **WPA Only**. This mode uses TKIP cipher. Some gaming and legacy devices work only in this mode.

To achieve better wireless performance use **WPA2 Only** security mode (or in other words AES cipher).

WPA Mode :

Cipher Type :

Group Key Update Interval : (seconds)

PRE-SHARED KEY

Enter an 8- to 63-character alphanumeric pass-phrase. For good security it should be of ample length and should not be a commonly known phrase.

Pre-Shared Key :



To configure wireless settings on the camera:

1. On the left menu of the Web interface, select **Network** and then **Wireless Client Mode**.

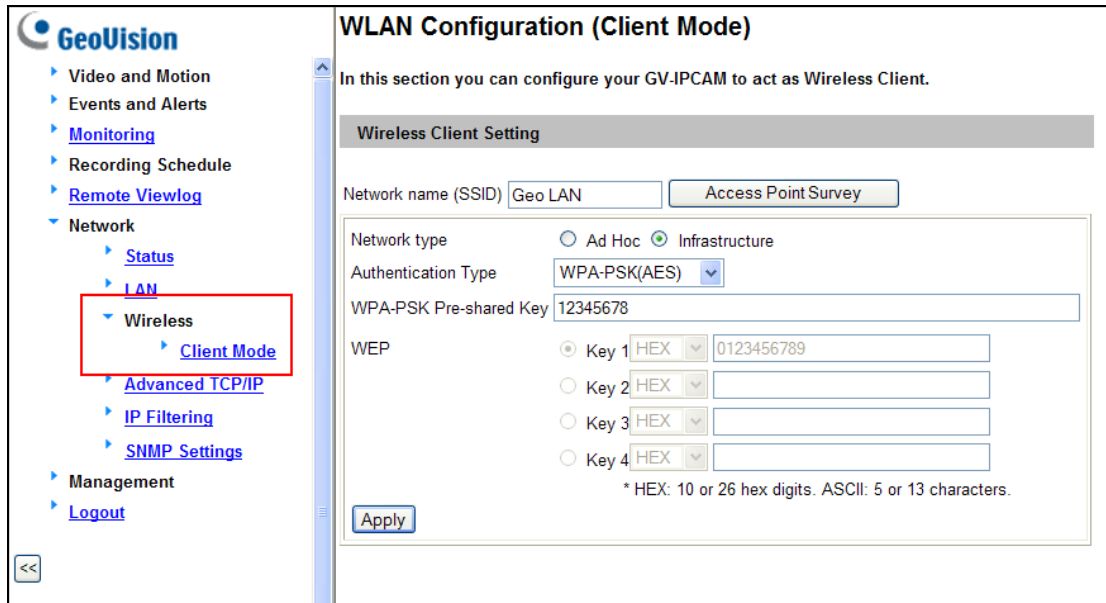

WLAN Configuration (Client Mode)

In this section you can configure your GV-IPCAM to act as Wireless Client.

Wireless Client Setting

Network name (SSID)

Network type Ad Hoc Infrastructure

Authentication Type

WPA-PSK Pre-shared Key

WEP

Key 1

Key 2

Key 3

Key 4

* HEX: 10 or 26 hex digits. ASCII: 5 or 13 characters.

2. Click the **Access Point Survey** button. All wireless routers nearby will be detected and listed. Select your router.

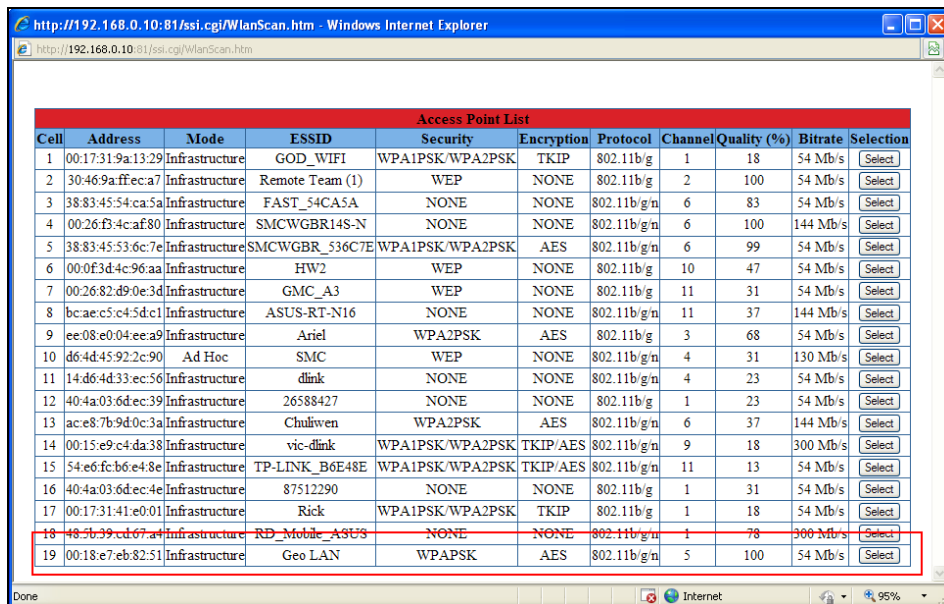

Cell	Address	Mode	ESSID	Security	Encryption	Protocol	Channel	Quality (%)	Bitrate	Selection
1	00:17:31:9a:13:29	Infrastructure	GOD_WIFI	WPA1PSK/WPA2PSK	TKIP	802.11b/g	1	18	54 Mb/s	<input type="button" value="Select"/>
2	30:46:9a:ff:ec:a7	Infrastructure	Remote Team (1)	WEP	NONE	802.11b/g	2	100	54 Mb/s	<input type="button" value="Select"/>
3	38:83:45:54:ca:5a	Infrastructure	FAST_54CA5A	NONE	NONE	802.11b/g/n	6	83	54 Mb/s	<input type="button" value="Select"/>
4	00:26:f3:4c:af:80	Infrastructure	SMCWGBR14S-N	NONE	NONE	802.11b/g/n	6	100	144 Mb/s	<input type="button" value="Select"/>
5	38:83:45:53:6c:7e	Infrastructure	SMCWGBR_536C7E	WPA1PSK/WPA2PSK	AES	802.11b/g/n	6	99	54 Mb/s	<input type="button" value="Select"/>
6	00:0f:3d:4c:96:aa	Infrastructure	HW2	WEP	NONE	802.11b/g	10	47	54 Mb/s	<input type="button" value="Select"/>
7	00:26:82:d9:0e:3d	Infrastructure	GMC_A3	WEP	NONE	802.11b/g	11	31	54 Mb/s	<input type="button" value="Select"/>
8	bc:ae:c5:c4:5d:c1	Infrastructure	ASUS-RT-N16	NONE	NONE	802.11b/g/n	11	37	144 Mb/s	<input type="button" value="Select"/>
9	ee:08:e0:04:ee:a9	Infrastructure	Ariel	WPA2PSK	AES	802.11b/g	3	68	54 Mb/s	<input type="button" value="Select"/>
10	d6:4d:45:92:2c:90	Ad Hoc	SMC	WEP	NONE	802.11b/g/n	4	31	130 Mb/s	<input type="button" value="Select"/>
11	14:d6:4d:33:ec:56	Infrastructure	dlink	NONE	NONE	802.11b/g/n	4	23	54 Mb/s	<input type="button" value="Select"/>
12	40:4a:03:6d:ec:39	Infrastructure	26588427	NONE	NONE	802.11b/g	1	23	54 Mb/s	<input type="button" value="Select"/>
13	ac:e8:7b:9d:0c:3a	Infrastructure	Chuliwen	WPA2PSK	AES	802.11b/g/n	6	37	144 Mb/s	<input type="button" value="Select"/>
14	00:15:e9:c4:da:38	Infrastructure	vic-dlink	WPA1PSK/WPA2PSK	TKIP/AES	802.11b/g/n	9	18	300 Mb/s	<input type="button" value="Select"/>
15	54:e6:fc:b6:e4:8e	Infrastructure	TP-LINK_B6E48E	WPA1PSK/WPA2PSK	TKIP/AES	802.11b/g/n	11	13	54 Mb/s	<input type="button" value="Select"/>
16	40:4a:03:6d:ec:4e	Infrastructure	87512290	NONE	NONE	802.11b/g	1	31	54 Mb/s	<input type="button" value="Select"/>
17	00:17:31:41:e0:01	Infrastructure	Rick	WPA1PSK/WPA2PSK	TKIP	802.11b/g	1	18	54 Mb/s	<input type="button" value="Select"/>
18	48:5b:39:cd:67:a4	Infrastructure	RD_Mobile_ASUS	NONE	NONE	802.11b/g/n	1	78	300 Mb/s	<input type="button" value="Select"/>
19	00:18:e7:eb:82:51	Infrastructure	Geo LAN	WPAPSK	AES	802.11b/g/n	5	100	54 Mb/s	<input type="button" value="Select"/>



3. Type the encryption information matching that on the router. For example, we have set up **WPA only** and **AES Mode** with a **Pre-shared Key** on the router.

WLAN Configuration (Client Mode)

In this section you can configure your GV-IPCAM to act as Wireless

Wireless Client Setting

Network name (SSID)

Network type Ad Hoc Infrastructure

Authentication Type

WPA-PSK Pre-shared Key

WEP

Key 1

Key 2

Key 3

Key 4

* HEX: 10 or 26 hex digits. ASCII

WIRELESS SECURITY MODE

To protect your privacy you can configure wireless security features. This device supports three wireless security modes including WEP, WPA-Personal, and WPA-Enterprise. WEP is the original wireless encryption standard. WPA provides a higher level of security. WPA-Personal does not require an authentication server. The WPA-Enterprise option requires an external RADIUS server.

Security Mode :

WPA

Use **WPA** or **WPA2** mode to achieve a balance of strong security and best compatibility. This mode uses WPA for legacy clients while maintaining higher security with stations that are WPA2 capable. Also the strongest cipher that the client supports will be used. For best security, use **WPA2 Only** mode. This mode uses AES(CCMP) cipher and legacy stations are not allowed access with WPA security. For maximum compatibility, use **WPA Only**. This mode uses TKIP cipher. Some gaming and legacy devices work only in this mode.

To achieve better wireless performance use **WPA2 Only** security mode (or in other words AES cipher).

WPA Mode :

Cipher Type :

Group Key Update Interval : (seconds)

PRE-SHARED KEY

Enter an 8- to 63-character alphanumeric pass-phrase. For good security it should be of ample length and should not be a commonly known phrase.

Pre-Shared Key :

4. Click **Apply**.
5. On the left menu of the Web interface, select **Network** and then **LAN**.

GeoVision

- Video and Motion
- Events and Alerts
- Monitoring
- Recording Schedule
- Remote Viewlog
- Network
 - Status
 - LAN**
 - Wireless
 - Client Mode
 - Advanced TCP/IP
 - IP Filtering
 - SNMP Settings
- Management
- Logout

LAN Configuration

In this section you can configure GV-IPCAM to work inside of LAN.

Optional Network type

Wired Ethernet Select this option to use wired 10/100Mbps ethernet

Wireless Select this option to use Wireless

LAN Configuration

Dynamic IP address Select this option to obtain IP address from a DHCP server

Static IP address Select this option to enter a Static IP address manually

IP Address:

Subnet Mask:

Router/Gateway:

Primary DNS:

Secondary DNS: (Optional)

PPPoE Select this option to establish a DSL connection

Username:

Password:

Wireless Settings

Dynamic IP address Select this option to obtain IP address from a DHCP server

Static IP address Select this option to enter a Static IP address manually

IP Address:



6. Select **Wireless**.
7. In the Wireless Settings section, select **Dynamic IP Address**.

Note: Typically, the router has the DHCP Server function and automatically assigns a dynamic IP address to any IP device on the LAN. If this is not the case, select **Static IP Address**.

8. Click the **Test DHCP** button. When the following dialog box appears with an IP address, it means you have set up the wireless connection successfully.

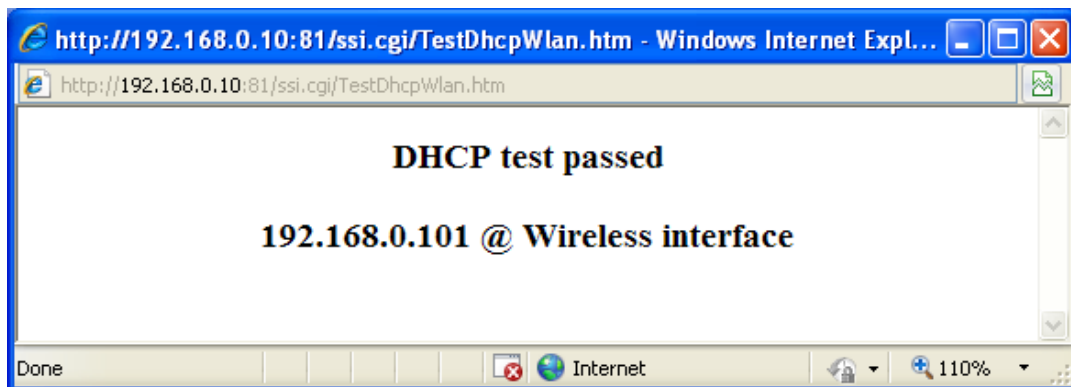

9. Unplug the network cable from the camera and have wireless connection now.

To remotely access the wireless camera on the LAN:

Follow steps 1 to 5 in the [B. Local Area Network](#) section earlier in this document.



D. Remote Viewing

1. Web Browser

To get the comprehensive features from the GV-IP Camera, you need to use **Internet Explorer 7.x or later** to access the Web interface. You can also use **Google Chrome**, **Mozilla Firefox** or **Safari** to access the IP camera, but only live viewing is available on these non-IE browsers.

For details on the supported functions on different Web browsers, refer to the technical notice: [The supported functions on different browsers for GV-IP devices.](#)

If you are using **Internet Explorer 8**, and cannot access the Web interface of the GV-IP Camera, you may need to allow previously unused ActiveX controls to run. For details, see *Appendix A. Setting for Internet Explorer 8, GV-IPCAM H.264 User's Manual* on the GV-IPCAM H.264 Software DVD.

2. GV-System/GV-NVR

You may find the Surveillance System Software DVD in the camera's package. The GV-System allows you to connect up to 32 GV-IP Cameras for live surveillance. To install the GV-System and connect to IP cameras, follow the steps below.

For further information on GV-NVR, see the GV-NVR Quick Start Guide:

[ftp://geo-demo-japan.dipmap.com/FAQ/Manual/V8.5.3.NVRQuickGuide\(NVRV853-QG-A-EN\).pdf](ftp://geo-demo-japan.dipmap.com/FAQ/Manual/V8.5.3.NVRQuickGuide(NVRV853-QG-A-EN).pdf)

To install the GV-System/GV-NVR:

1. Insert the Surveillance System software DVD to a computer. It runs automatically.

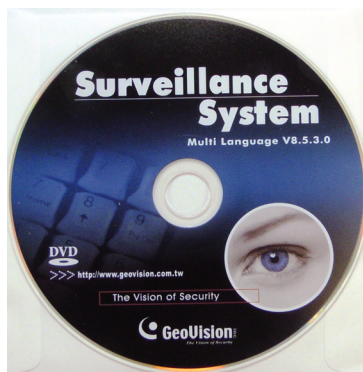



2. When this window appears, click **Install GeoVision Vxxxx System**.

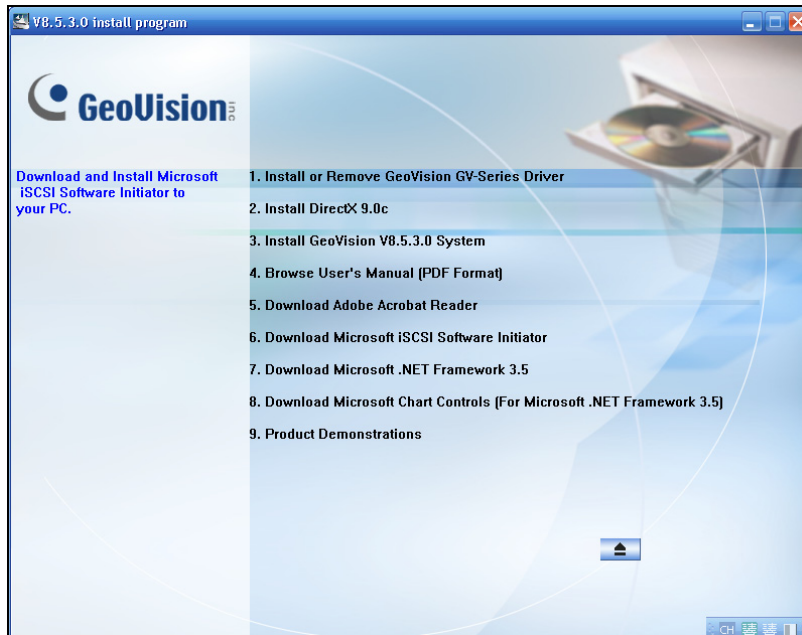

3. Click **GeoVision Main System**.
4. When this dialog box appears, select **GV-NVR** and click **Next**.

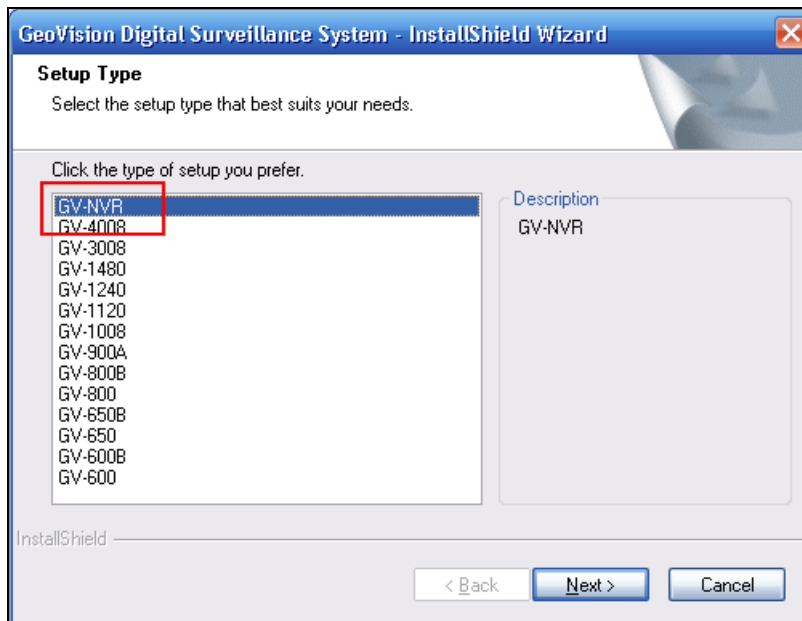

5. Follow the on-screen instructions to complete the installation.



To connect to the GV-IP Camera:

1. Run and log in the GV-NVR.

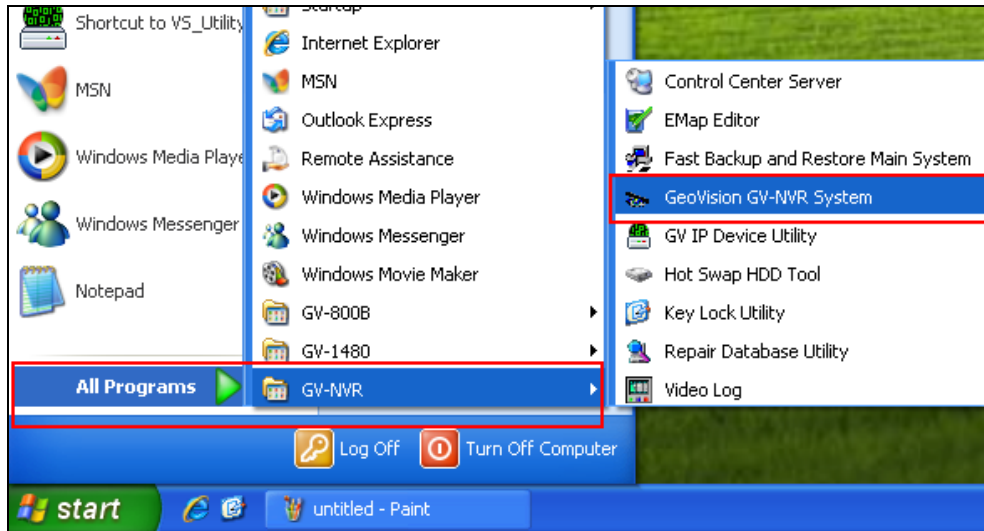

2. On the main screen, click the **Configure** button, select **System Configure** and select **IP Camera Install**.

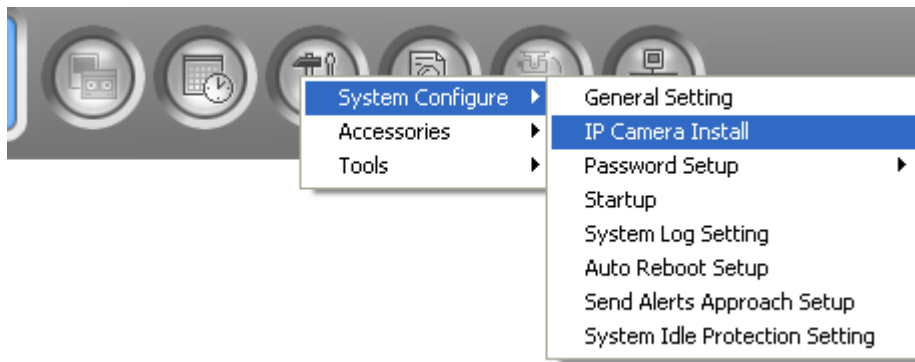

3. Select **Add Camera**.

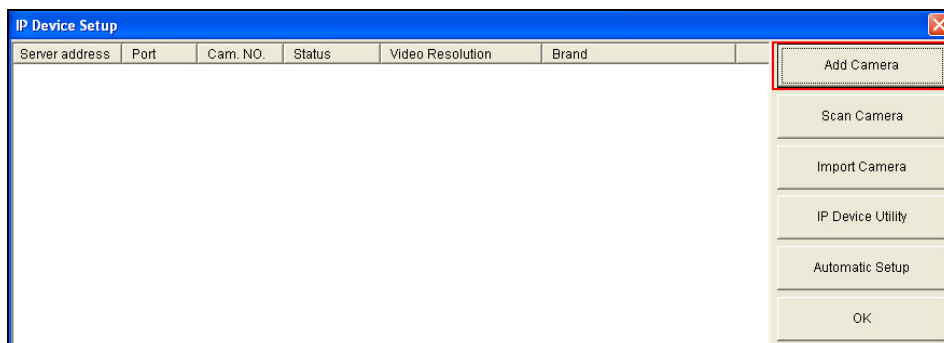



4. Type the connection information, login username and password of the GV-IP Camera.

Select Brand

Server IP :

HTTP Port :

User name :

Password :

Brand :

Device :

Message :

Domain name/public IP of the camera (linked directly to the Internet). Or domain name/public IP of the router.

Keep default value 81, or type the specific port number of the camera.

- **Server IP:** Type the domain name or public IP address of the camera. **If the camera is residing on the LAN, type the domain name or public IP address of the router, for example, geoipcamera.dlinkddns.com.**

Refer to [Step 3 Registering a domain name for the router](#) in the *B. Local Area Network* section earlier.

- **HTTP Port:** Keep the default value 80. **If the camera is residing on the LAN, type the specific HTTP port of the camera.**

For example, type 81 for Camera 1 or type 82 for Camera 2.

Refer to [Step 2 Assigning a different port to each camera](#) in the *B. Local Area Network* section earlier.

- **Username:** Type the login username of the camera. The default value is **admin**.
- **Password:** Type the login password of the camera. The default value is **admin**.
- **Brand:** Select **GeoVision**.
- **Device:** Select the model name of the camera.



- When the following dialog box appears, keep the default VSS (streaming) port value 10000. **If the camera is residing on the LAN, type the specific VSS port of the camera.**
For example, type 10000 for Camera 1 or type 10001 for Camera 2.

Refer to [Step 2 Assigning a different port to each camera](#) in the *B. Local Area Network* section earlier.

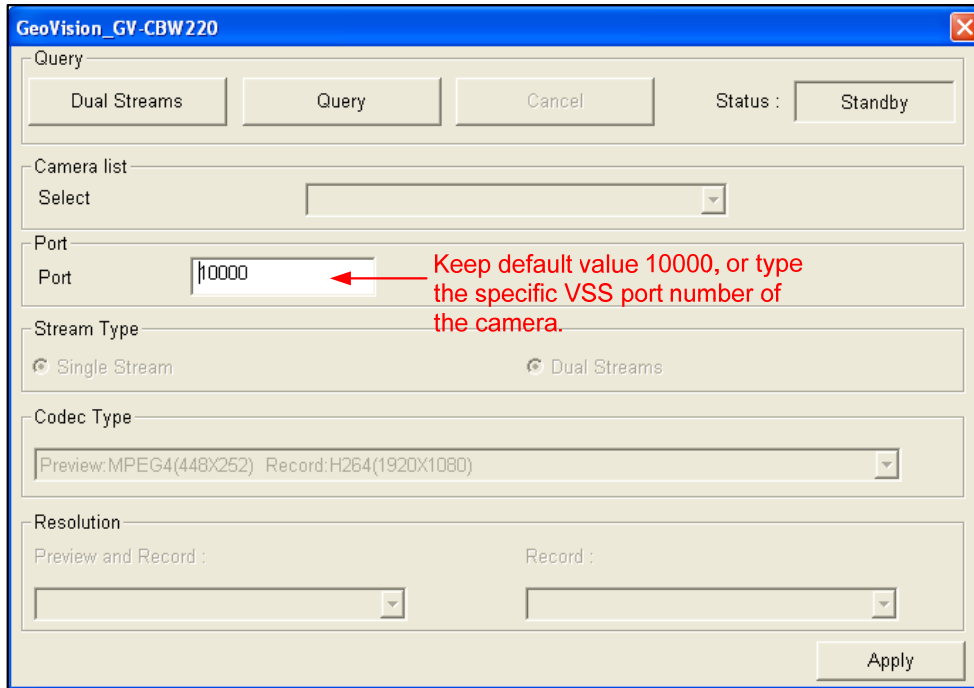

- Click **Query**. When the Standby status appears, it indicates the camera is connected. Click **Apply**.
- Right-click the camera, select **Display Position** and select a camera channel to display.

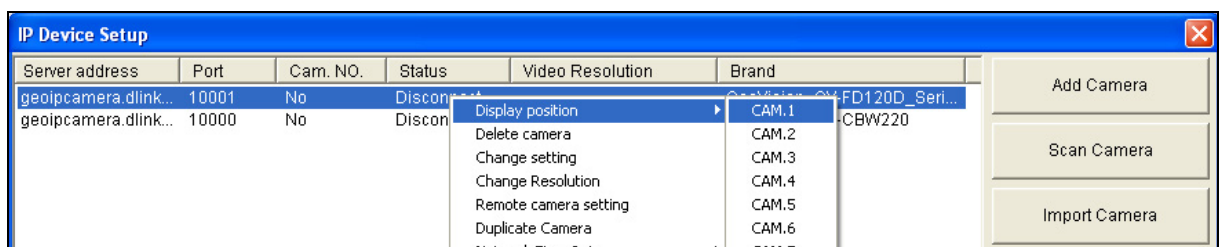

- When the Connected status displays, the live image of the camera is displayed successfully on the GV-System.

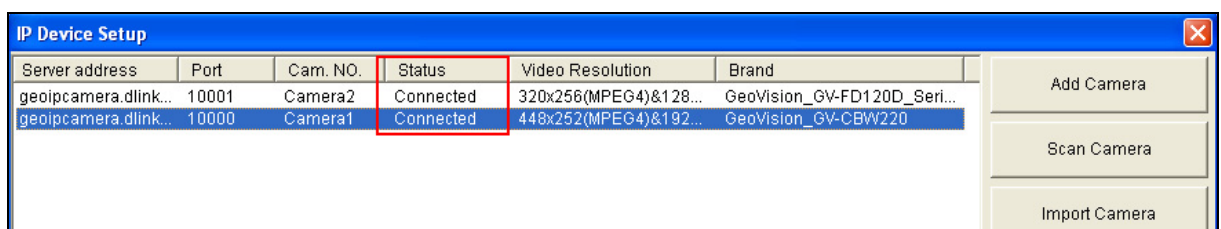



3. Mobile Phone

You can use a variety of mobile phones to access the GV-IP Camera remotely. For the detailed introduction and instructions, see *Chapter 18 Mobile Phone, GV-IPCAM H.264 User's Manual* on the GV-IPCAM H.264 Software DVD. In this document, we only introduce how to connect to the IP camera using Apple and Android smartphones.

For users of iPhone, iPod touch and iPad:

1. Download and install **GV-Eye / GV-Eye HD** from App Store. The GV-Eye / GV-Eye HD icon appears on the desktop.

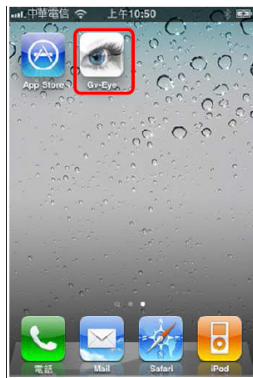

GV-Eye icon on iPhone / iPod Touch

2. Tap the **Add** button  to add a camera for connection.
3. Type the connection information, login username and password of the camera.

Domain name/public IP of the camera (linked directly to the Internet). Or domain name/public IP of the router.

Keep default value 10000, or type the specific VSS port number of the camera.



- **Host name:** Name the camera.
- **Domain/IP:** Type the domain name or public IP address of the camera. **If the camera is residing on the LAN, type the domain name or public IP address of the router, for example, geoipcamera.dlinkddns.com.**

Refer to [Step 3 Registering a domain name for the router](#) in the *B. Local Area Network* section earlier.

- **Port:** Keep the default VSS (streaming) port value 1000. **If the camera is residing on the LAN, type the specific VSS port of the camera.**

For example:

For Camera 1, type 10000.

For Camera 2, type 10001.

Refer to [Step 2 Assigning a different port to each camera](#) in the *B. Local Area Network* section earlier.

- **Username:** Type the login username of the camera. The default value is **admin**.
- **Password:** Type the login password of the camera. The default value is **admin**.

4. Tap the **Save** button. The camera is added to the connection list. Click the camera on the list to access its live images.

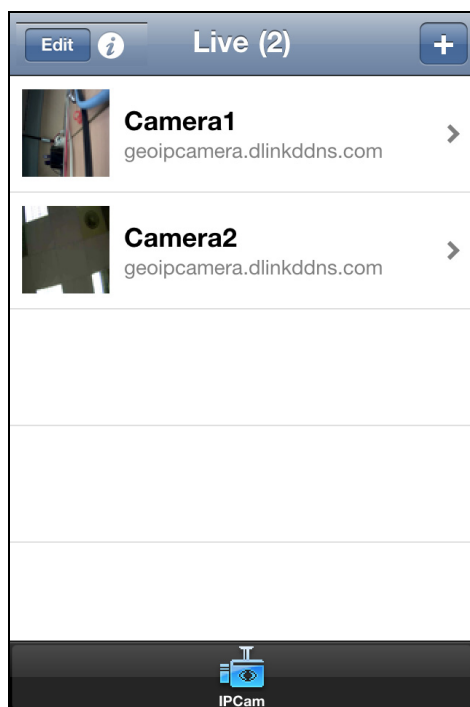

For detailed instructions, see this document

<http://www.geovision.com.tw/upload/en/mobileap/GV-Eyev112.pdf>



For users of Android smartphones and tablets:

1. Download and install **GV-Eye** from Android Market. The GV-Eye icon appears on the desktop.



2. Tap the **Menu** button to access the address book.
3. Tap the **Add** button  to add a camera for connection.
4. Type the connection information, login username and password of the camera.

Domain name/public IP of the camera (linked directly to the Internet). Or domain name/public IP of the router.

Keep default value 10000, or type the specific VSS port number of the camera.



- **Profile name:** Name the camera.
- **IP:** Type the domain name or public IP address of the camera. **If the camera is residing on the LAN, type the domain name or public IP address of the router, for example, geipcamera.dlinkddns.com.**

Refer to [Step 3 Registering a domain name for the router](#) in the *B. Local Area Network* section earlier.

- **Port:** Keep the default VSS (streaming) port value 1000. **If the camera is residing on the LAN, type the specific VSS port of the camera.**

For example:

For Camera 1, type 10000.

For Camera 2, type 10001.

Refer to [Step 2 Assigning a different port to each camera](#) in the *B. Local Area Network* section earlier.

- **Username:** Type the login username of the camera. The default value is **admin**.
- **Password:** Type the login password of the camera. The default value is **admin**.

5. Tap the **Connection** button  to connect to the camera and see the live images.

For detailed instructions, see this document

http://www.geovision.com.tw/upload/en/mobileap/GV-Eye_AndroidV10.pdf



F. Remote Playback

You can remotely play back the video files saved on the memory card of the GV-IP Camera.

1. For the first-time user, you need to install the **Remote ViewLog** player from the GV-IPCAM H.264 Software CD to the remote computer.



2. Install **GeoVision Remote ViewLog**.



3. Run **Remote ViewLog**.

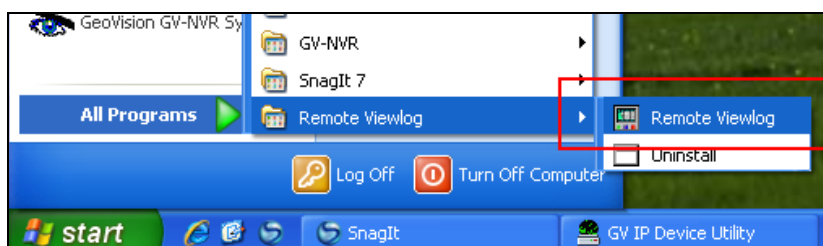



- When the Remote ViewLog player appears with the following selections, select **Remote ViewLog Service**.

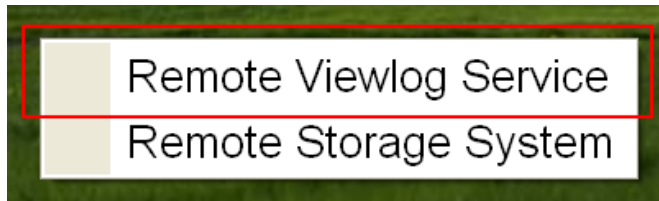

- Type the connection information, login username and password of the camera.

Domain name/public IP of the camera (linked directly to the Internet). Or domain name/public IP of the router.

Keep default value 5552, or type the specific ViewLog port number of the camera.

- IP Address:** Type the domain name or public IP address of the camera. **If the camera is residing on the LAN, type the domain name or public IP address of the router, for example, geoipcamera.dlinkddns.com.**

Refer to [Step 3 Registering a domain name for the router](#) in the *B. Local Area Network* section earlier.

- Port:** Keep the default ViewLog port value 5552. **If the camera is residing on the LAN, type the specific ViewLog port of the camera.**

For example:

For Camera 1, type 5552.

For Camera 2, type 5553.

Refer to [Other ports used by GV-IP Camera](#), *Step 2 Assigning a different port to each camera* in the *B. Local Area Network* section earlier.

- ID:** Type the login username of the camera. The default value is **admin**.
- Password:** Type the login password of the camera. The default value is **admin**.
- Host Type:** Select **GV-IP Device**.



6. Click **OK**. The video files of the camera are displayed on the Video Event List, and playback starts.
7. Next time when you want to play back video from any IP camera on the same computer, just log in the camera and select **Remote ViewLog** on the left menu to start the Remote ViewLog player.

